



Birlea

Suppliers of inspiration

Assembly Instructions

Thank you for
purchasing a
Birlea product.

For a chance to win a Love 2 Shop voucher simply post a picture of your new product on your preferred social channels tagging Birlea Furniture and using the hashtag **#ShareYourStyle** and **#Birlea**. One winner will be selected at random each month.

To view our full terms and conditions please visit www.birlea.com

Are you happy with your purchase?

Yes: That's great, we would love to hear more from you. Please leave us a review on our social media channels or Trustpilot. Your feedback will be greatly appreciated

No: If for any reason there is something missing, indifferent or incorrect with your order, please contact the retailer you purchased the item from. We will work with the retailer to resolve your issue as quickly as possible.



Berlin Fabric Ottoman Bed - KING

Assembly Instructions

Before you begin...

1. Please check you have received the correct product.
2. Unpack all boxes and lay out each component on the floor.
3. Check your product for any damage that may be immediately obvious. If damage is identified, please contact your retailer.
4. Please read through these instructions thoroughly to ensure you have constructed your bed correctly.

For Care and Maintenance of your bed...

- Always assemble in your desired room of use.
- Always check all screws and fixings periodically to ensure they are still secure.
- Do not push or pull this bed as it will cause damage.
- Always lift this bed with a second person to prevent damage or injury.
- Keep any sharp objects away from this bed Frame.

For your Health and Safety...

- Please don't not jump on this Bed.
- Do not use this bed if you find missing, damaged or worn parts. Please contact your retailer.
- Please do not use this bed until you have fully secured all fixings.
- Please keep all small components away from children.
- Please ensure this bed is on an even, level surface.

Also...

If your desired room of choice has a non-carpeted surface please ensure that you use some form of anti-slip protection and do not place directly on the wooden floor. This will prevent the bed from moving and therefore collapsing which will void your guarantee..

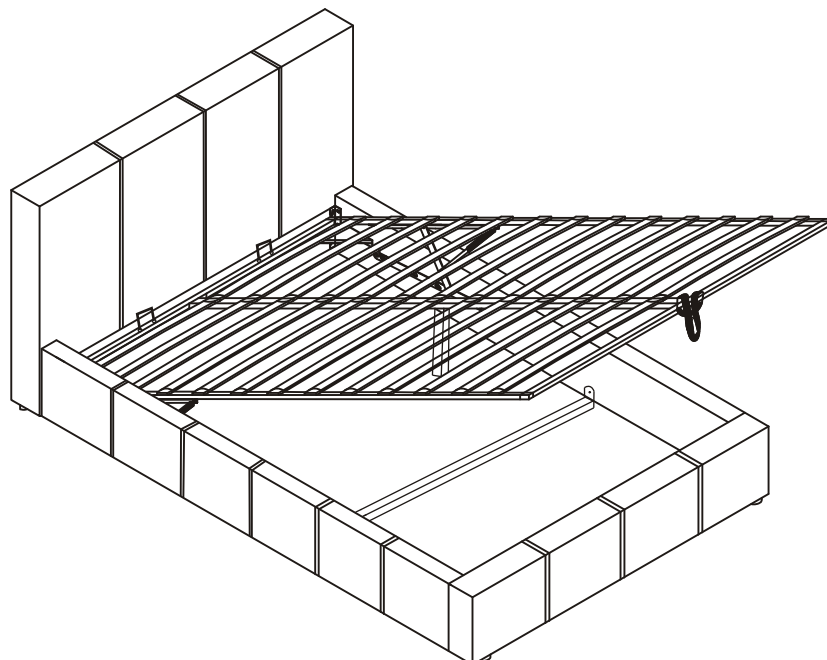

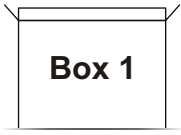

Box 1

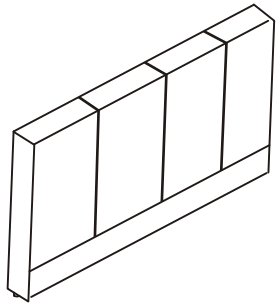

3. Headboard (x1)

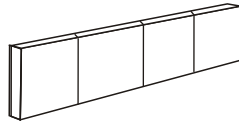

2. Footboard (x1)

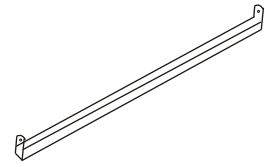

5. Bed Cross Bar(x1)

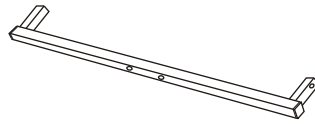

15. Back Frame Rail(x1)

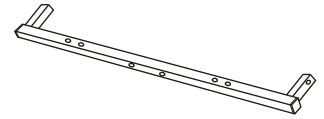

14. Front Frame Rail(x1)

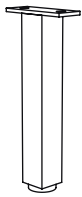

10. Support Leg (x1)

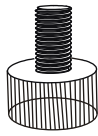

8. Legs (x4)

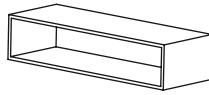

M. Slat Caps (x28)

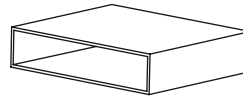

N. Centre Slat Caps (x14)



11. metal hook (X2)



1. Baton (x1)

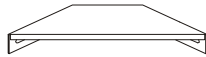

7. corner bracket (X4)



12. Pull Strap (x1)



A. M5 Allen Key (x1)

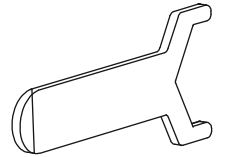

F. Spanner (x1)



I. M4 Allen Key (x1)

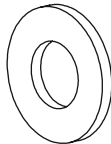

D. Flat Washer (X8)



C. Spring Washer (x8)

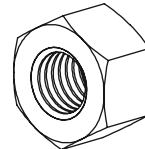

E. Nuts (x12)

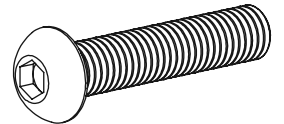

L. M8x45mm Bolts (x4)

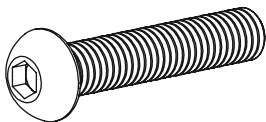

H. M8x40mm Bolts (x6)

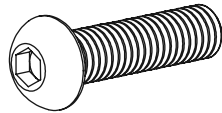

B. M8x30mm Bolts (x8)

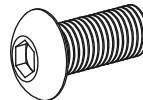

J. M8x16mm Bolts (x4)

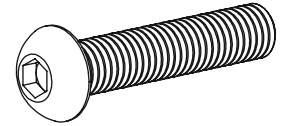

K. M8x65mm Bolts (x4)

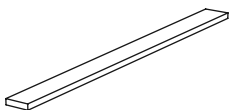

9. Slats(x28)

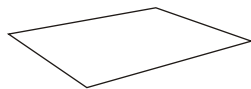

13. Woven Fabric (X1)

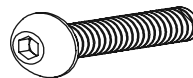

G. M6x16mm Bolts (x10)

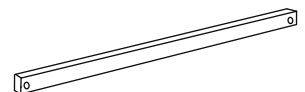

18. Cross Support Bar(x2)

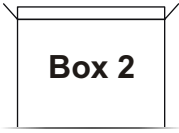

Box 2

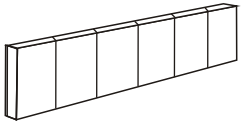

4. Side Rails (x2)

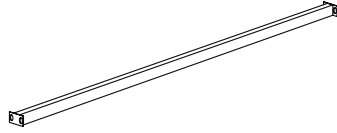

6. Centre Support Rail (x1)

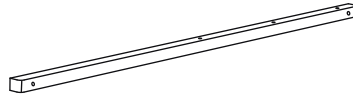

16. Left Right Frame Rail (x1)

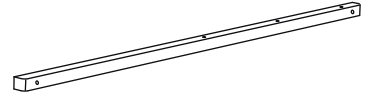

17. Right Frame Rail (x1)

Step 1

Unpack all components from the boxes and check you are not missing anything. Please check these against the list on page 3 & 4. Should you identify any missing components, please contact the retailer you purchased the bed from.

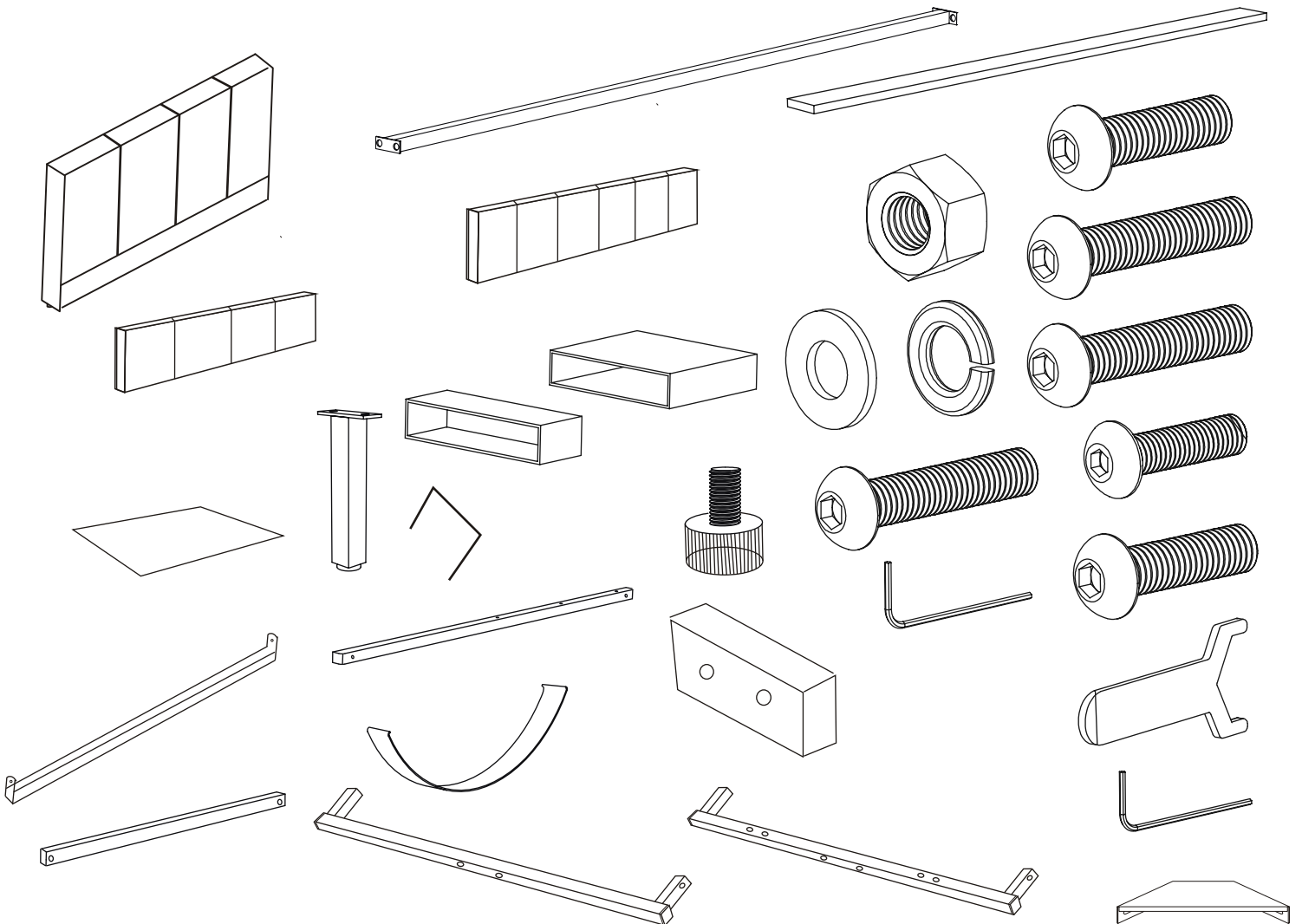

Step 2

Attach 2x Legs (8) to the 1x Headboard (3) and then attach 2x Legs (8) to the 1x Footboard (2) using the Allen Key (A), 4x M8x30mm Bolts (B), 4x Spring Washer (C) and 4x Flat Washer (D). **DO NOT FULLY TIGHTEN BOLTS DO NOT USE ANY POWER TOOLS AS THIS MAY DAMAGE THE BED FRAME AND WILL INVALIDATE ANY CLAIMS.**

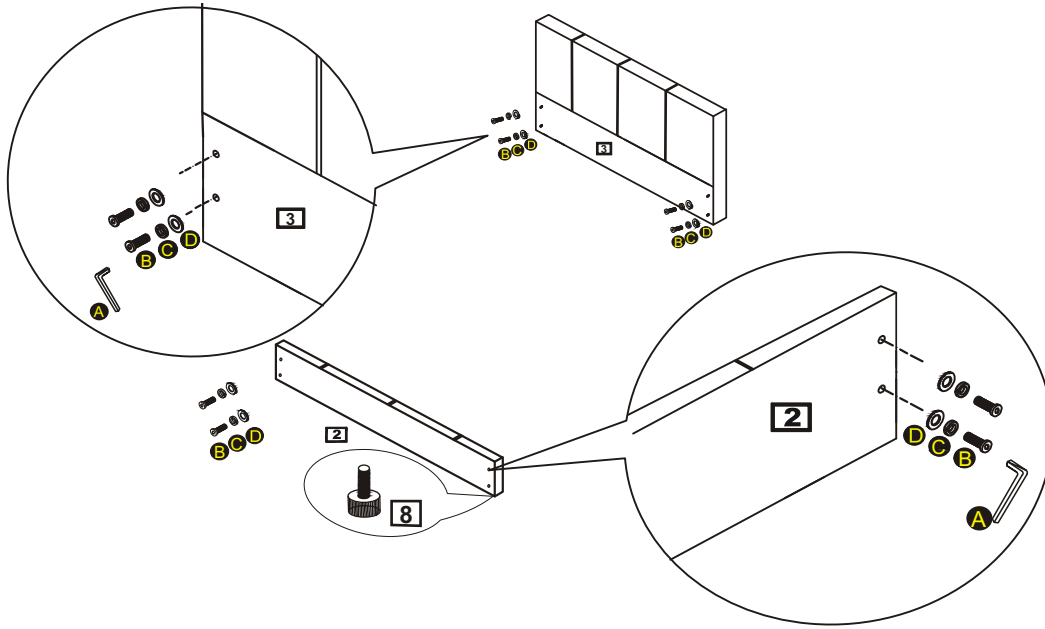

- 3** Headboard x1
- 2** Footboard x1
- 8** Legs x 4
- B** Bolts (M8x30mm) x8
- C** Spring washer x8
- D** Flat washer x8
- A** M5 Allen Key

Step 3

To fix the side rails (4) to the headboard (3) and footboard (2) you will need to use hardware parts B, C, D with the M5 allen key (A).

To fix the wooden block (1) to the footboard (2) you will need to use hardware parts L with the M5 allen key (A).

To attach the corner bracket with pad (7) to the headboard (3), footboard (2) and side rails (4) you will need to use hardware parts G and the M4 allen key.

To fix the cross bar (5) to the side rails (4) you will need to use hardware G With M4 allen key (I).

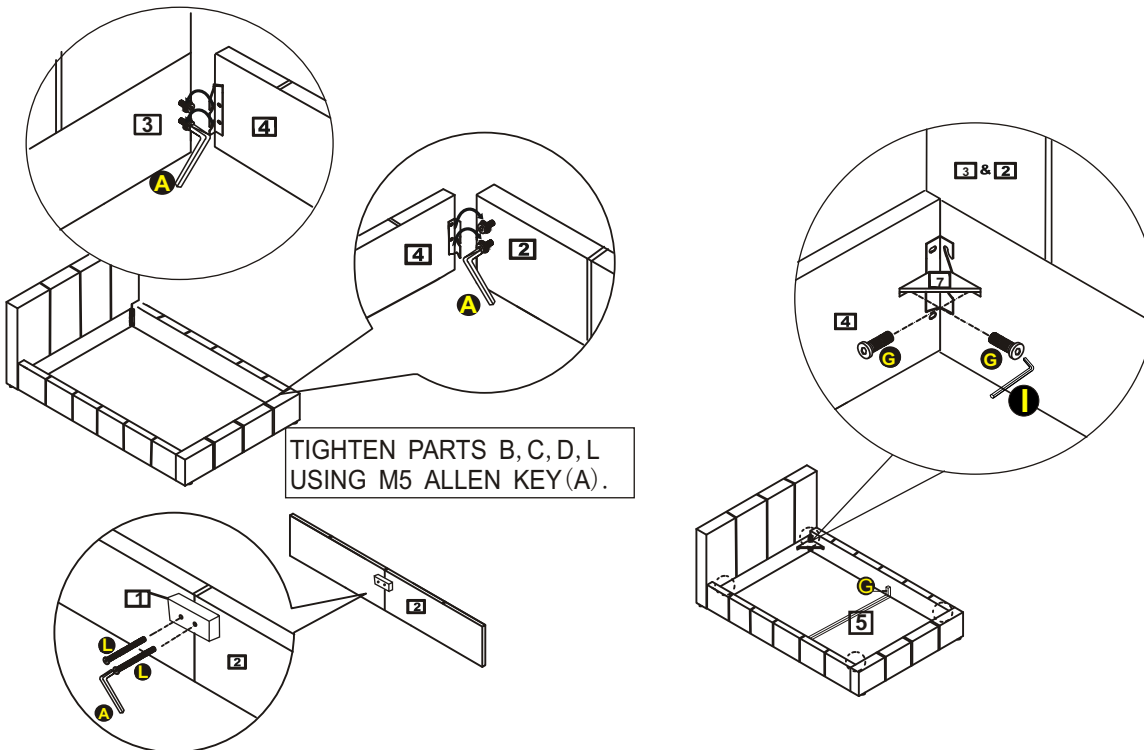

- 3** Headboard x1
- 2** Footboard x1
- 4** Side rail x 2
- 1** Wooden Block x 1
- 7** Corner Bracket with Pad x 4
- 5** Cross Bar
- G** Bolts (M6x16mm) x10
- L** Bolts (M8x45mm) x 2
- I** M4 Allen Key
- A** M5 Allen Key

MAKE CERTAIN THE BED IS SQUARE AS SHOWN.

Note: THEN tighten all bolts 100% using allen key

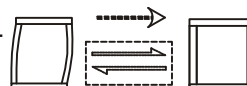

Step 4

To attach the front frame rail (14) and back frame rail (15) to the left frame rail (16) and right frame rail (17), you will need hardware parts J with the M5 allen key (A).

To attach the centre support bar (6) to the front frame rail (14) and back frame rail (15), you will need hardware parts H and E with the M5 allen key (A) and the M14 spanner (F).

To attach the support leg (10) to the centre support bar (6), you will need hardware parts H and E with the M5 allen key (A) and the M14 spanner (F).

Insert the metal hook (11) to the front frame rail (14).

DO NOT use any power tools as this may damage the bed frame and will invalidate any claims.

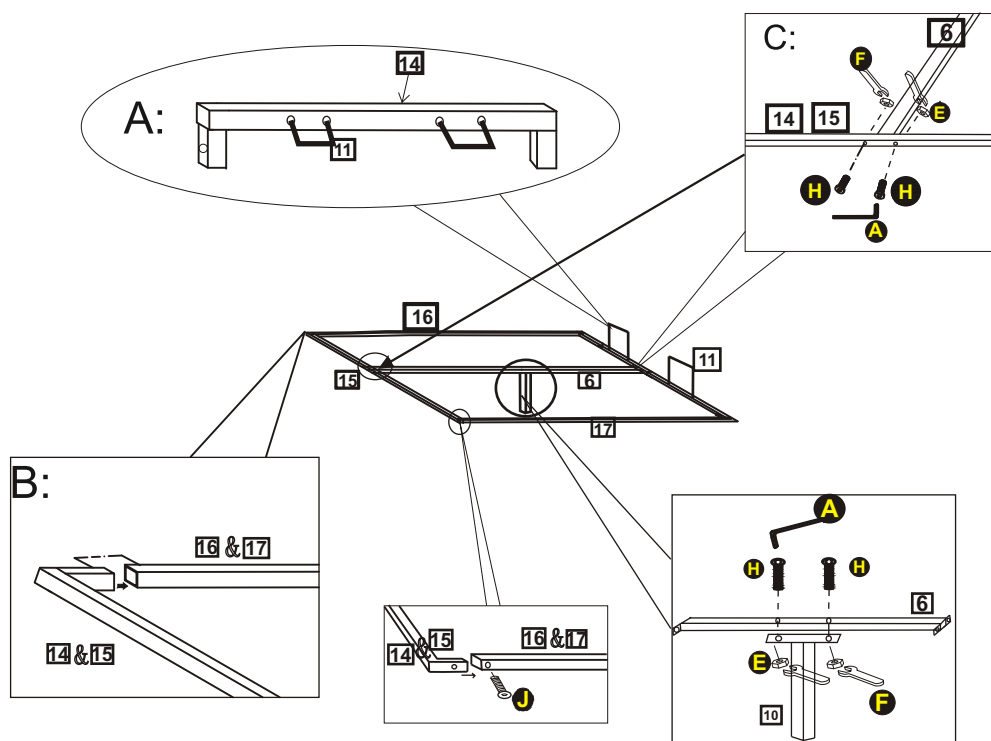

- 14 Front Frame Rail x1
- 15 Back Frame Rail x1
- 6 Centre Support Bar x1
- 10 Support Legs x1
- 11 Metal Hook x2
- 16 Left Frame Rail x1
- 17 Right Frame Rail x1
- H Bolts (M8x40mm) x6
- E Nuts (M8x13mm) x6
- F Spanner (13)
- A M5 Allen Key x1
- J Bolts (M8x16mm) x4

Step 5

To attach the metal frame (14/15/16/17) and cross support bar (18) to the gas lift pre-fixed to the side rails, you will need to use hardware parts K, E and L with the M5 allen key (A) and the M14 spanner (F).

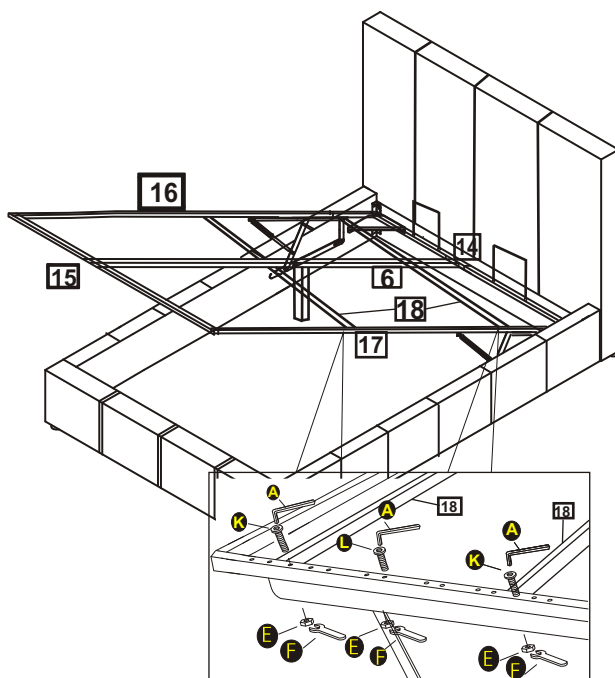

- 18 Cross Support Bar x2
- K Bolts (M8x65mm) x4
- E Nuts (M8x13mm) x6
- F Spanner (13)
- A M5 Allen Key
- L Bolts (M8x45mm) x2

Step 6

To attach the pull strap (12) to the back frame rail (15) you will place the pull strap (12) beneath the metal frame and then pull the strap on the inner side of the frame through the strap on the outer side of the frame to form a knot.

To assemble the slats(9) place a single plastic cap(M) onto each end of every slat then you need to push centre slat caps(N) into the metal frame.

DO NOT use any power tools as this may damage the bed frame and will invalidate any claims.

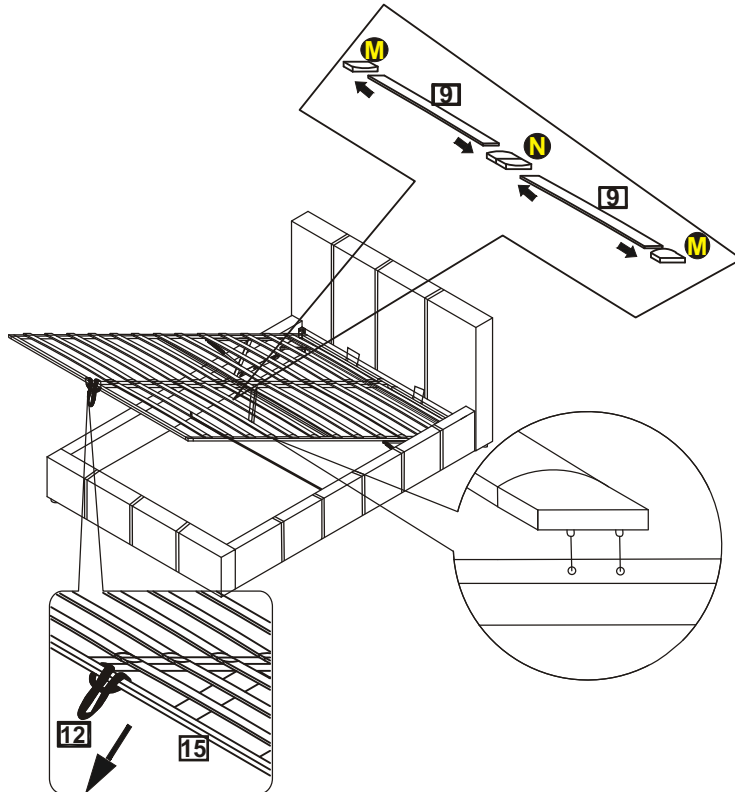

- 12** Pull Strap x1
- 9** Slats X28
- M** Plastic Slat Caps x28
- N** Centre Slat Caps x14

Step 7

Tilt the bedframe on to its side and attach the woven fabric (13).

CAUTION: WHEN BED TILTED BE CAREFUL OF THE OTTOMAN FRAME SPRINGING OUT.

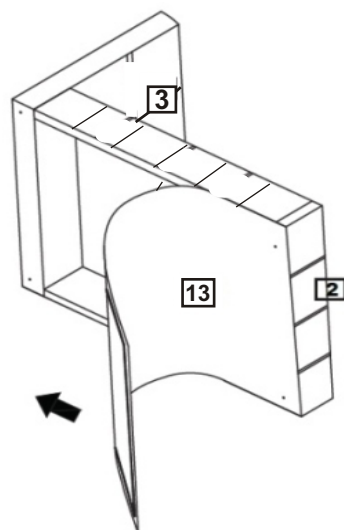

- 13** Woven Fabric x1