



# Birlea

Suppliers of inspiration

## Assembly Instructions

---

Thank you for purchasing a Birlea product.

For a chance to win a Love 2 Shop voucher simply post a picture of your new product on your preferred social channels tagging Birlea Furniture and using the hashtag #ShareYourStyle and #Birlea. One winner will be selected at random each month.

To view our full terms and conditions please visit our website. [www.birlea.com](http://www.birlea.com)

---

### Are you happy with your purchase?

**Yes:** That's great, we would love to hear more from you. Please leave us a review on our social media channels or Trustpilot. Your feedback will be greatly appreciated.

**No:** If for any reason there is something missing, indifferent or incorrect with your order, please contact the retailer you purchased the item from. We will work with the retailer to resolve your issue as quickly as possible.



[www.birlea.com](http://www.birlea.com)



# Birlea

Suppliers of inspiration

## Assembly Video

---

For a step by step guide on how to build our Lynx 4 Drawer Chest visit our YouTube channel 'BirleaFurnitureLtd' or alternatively scan the QR code on your smart phone.



---

### How to scan a QR code from an apple device

**Step One:** Open up the camera app

**Step Two:** Hold the device's camera up to the QR code

**Step Three:** Your Apple device will automatically recognise the QR code and provide you with a link to the video.

### How to scan a QR code from an android device

**Step One:** Download the QR Code reader application from the Play Store.

**Step Two:** Open the QR code application and open the camera.

**Step Three:** Your Android device will automatically recognise the QR code and provide you with a link to the video.

### How to scan a QR code from a Window's device

**Step One:** Open up the camera app

**Step Two:** Hold the device's camera up to the QR code

**Step Three:** Your Window device will automatically recognise the QR code and provide you with a link to the video.

Please ensure that you device is up to date with the latest operating system.



# Birlea

Suppliers of inspiration

Vendor: S000139



## ASSEMBLY INSTRUCTIONS LYNX 4 DRAWER CHEST

**IMPORTANT: READ THESE INSTRUCTIONS CAREFULLY BEFORE ATTEMPTING TO ASSEMBLE OR USE YOUR LYNX 4 DRAWER CHEST.**

**PLEASE KEEP THESE INSTRUCTIONS FOR FUTURE REFERENCE.**

### **ASSEMBLY:**

Assembly should be carried out with this item laying flat, not standing upright.  
Assemble on a soft, clean surface to prevent damages.  
To erase the numbers printed on the pieces, use the rubber into the accessories pack.

### **HEALTH & SAFETY:**

DO NOT use this chest if any parts are missing, damaged or worn.  
DO NOT use this chest unless all fixings are secured.  
Always use on a level, even surface.

### **CARE & MAINTENANCE:**



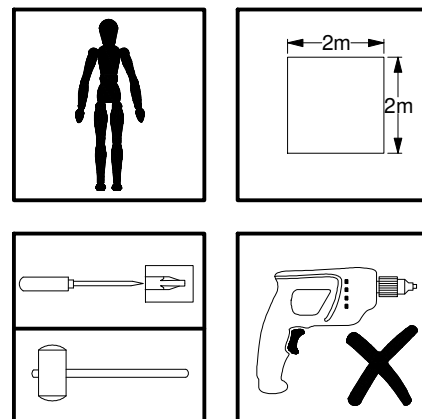
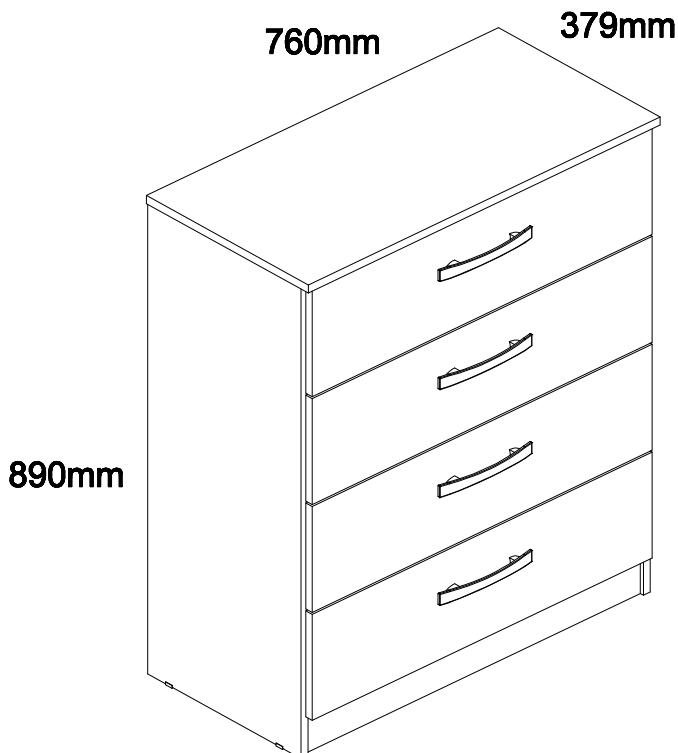



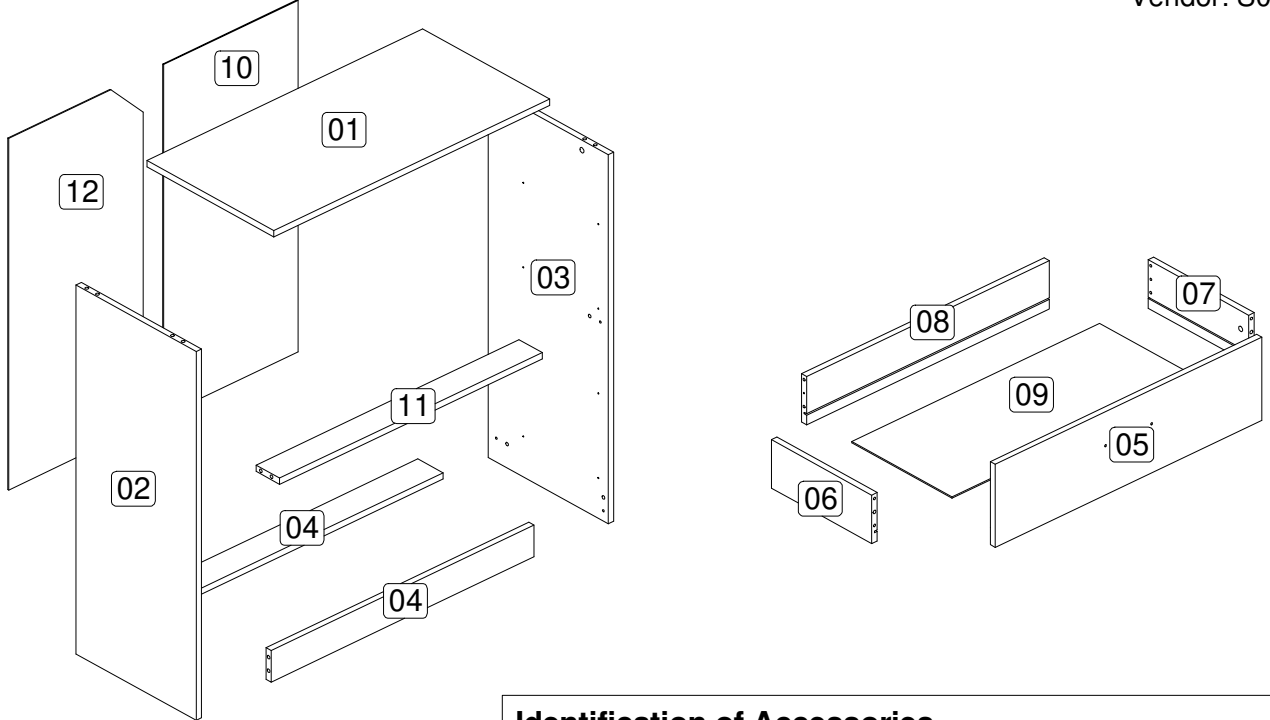







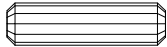

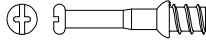
Periodically check all screws & fixings to ensure they are secure.  
DO NOT push the chest as this will damage the base.  
Always lift the chest with two people to reposition.  
Keep any sharp objects away from the chest.

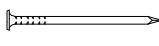
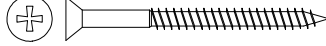

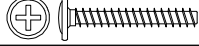
[www.birlea.com](http://www.birlea.com)

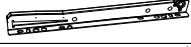

**Identification of Accessories**

Part	Description	Qty
A	5 x 60 mm Screw 	1
A1	Glue 	1
A6	Spine 	1
B3	Bushing 	1
E	8 x 30mm Wooden Dowel 	42
E7	Small Plastic Foot 	4
E9	Strap 	1
J	Simple Minifix Screw 	18
L	Cam Lock 	18
M	Plastic Cap 	8
N	10 x 10mm Tack 	35
O	4.5 x 45mm Screw 	8
P5	3,5 x 14mm Screw 	33
T	3.5 x 25mm Screw 	8
W2	Handles 	4
XA	Metallic slide the left field 	4
XB	Metallic slide the right field 	4
XC	Drawer slide left 	4
XD	Drawer slide right 	4

**Parts List**

Part	Description	Box	Qty
01	Top Panel	1	1
02	Left Panel	1	1
03	Right Panel	1	1
04	Plinth	1	2
05	Drawer Front	1	4
06	Left Drawer Panel	1	4
07	Right Drawer Panel	1	4
08	Drawer Back	1	4
09	Drawer Base	1	4
10	Back Panel	1	1
11	Centre Support	1	1
12	Back Panel	1	1

**\*\* You will need a small mallet and a screwdriver for assembly.**  
**\*\* Some screws and wooden dowel may remain.**  
**\*\* Wall plug and screw is supplied to attach strap to the wall.**

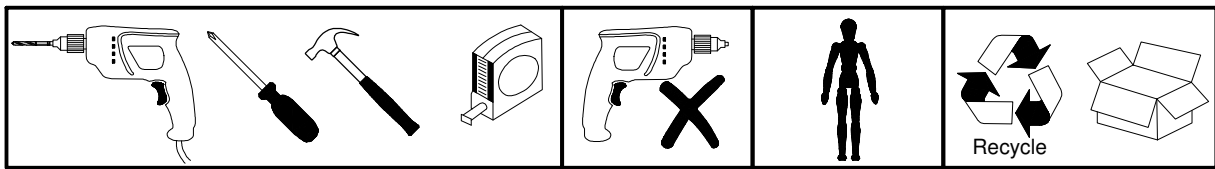

**Step 1:** Attach the metallic slide (XB) to the right panel (3) using hardware part P5. Insert hardware part E using a small mallet (not provided) and the part J using screwdriver (not provided). **DO NOT use any power tools as this may damage the frame and will invalidate any claim.**

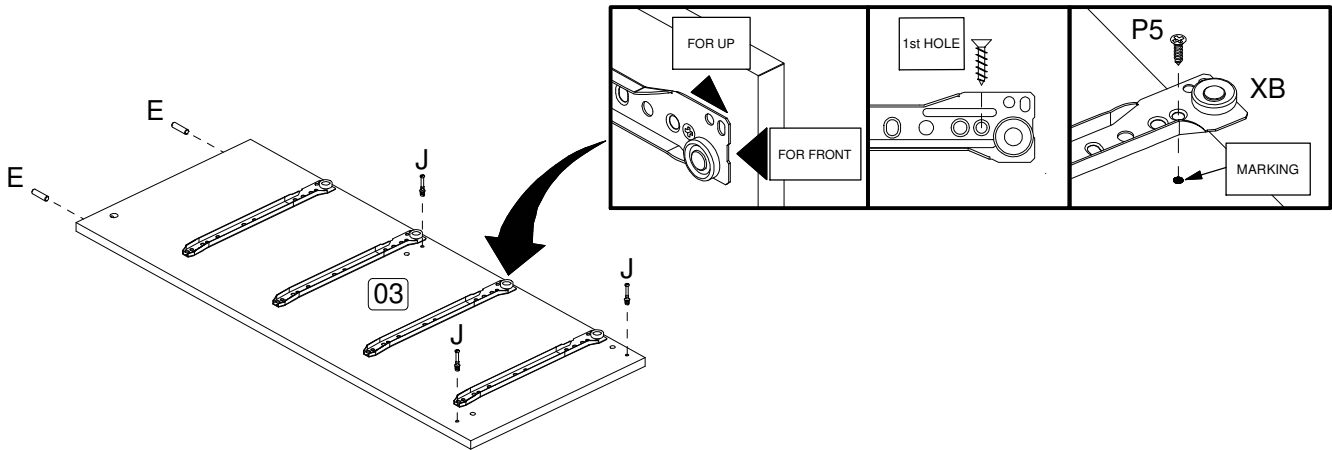

**Step 2:** Attach the metallic slide (XA) to the left panel (2) using hardware part P5. Insert hardware part E using a small mallet (not provided) and the part J using screwdriver (not provided). **DO NOT use any power tools as this may damage the frame and will invalidate any claim.**

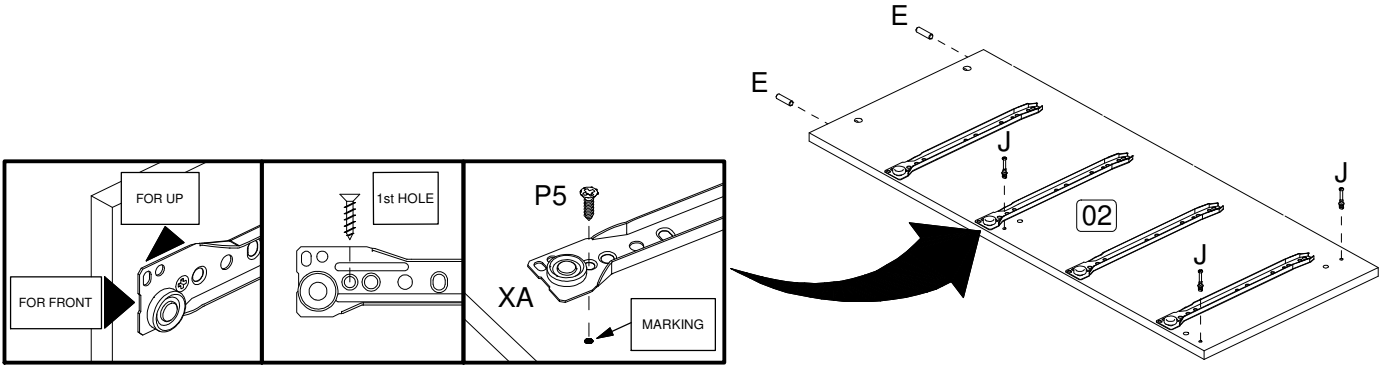

**Step 3:** Insert hardware parts E and J as shown using hardware part A1, a small mallet and a screwdriver (not provided). **DO NOT use any power tools as this may damage the frame and will invalidate any claim.**

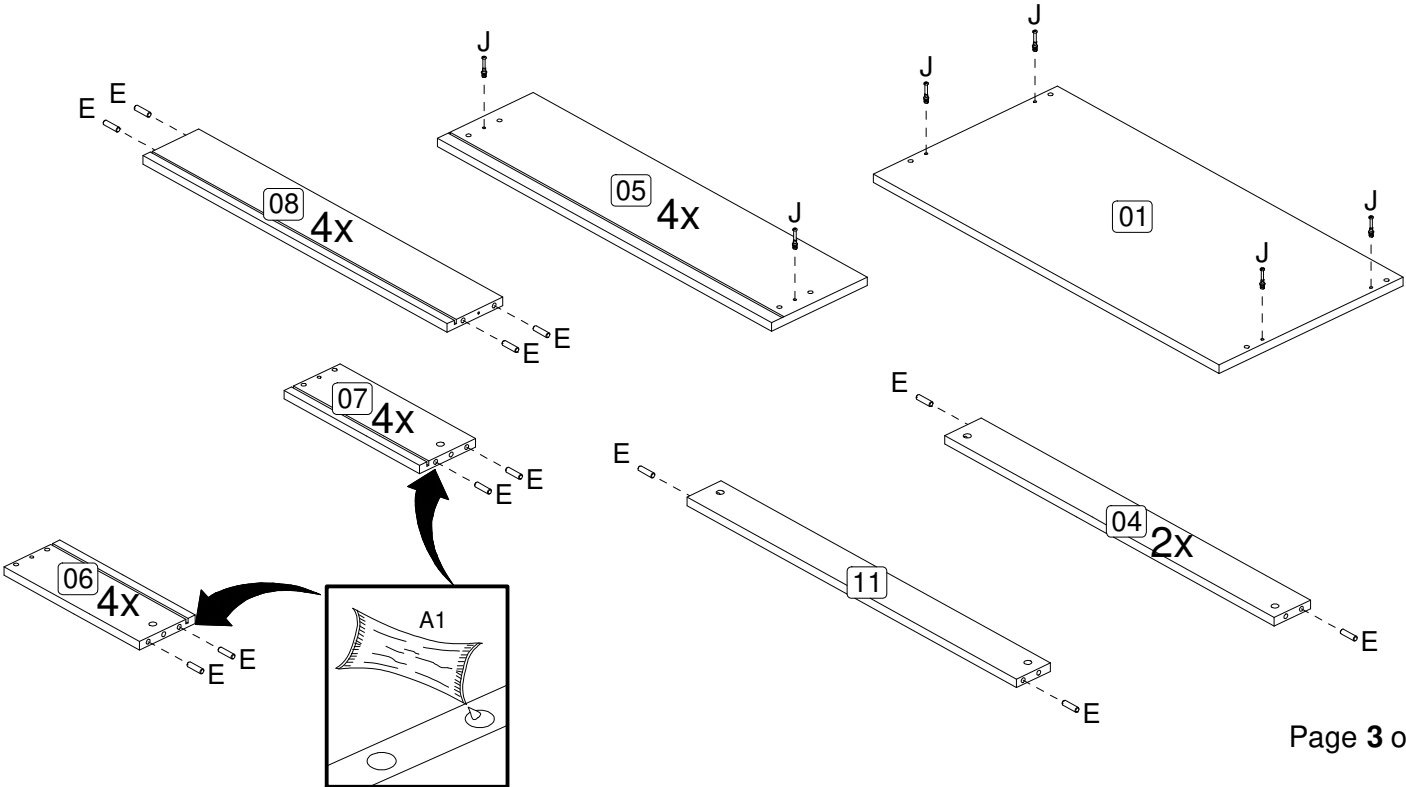

**Step 4:** Attach the left panel (2) and right panel (3) to the plinths (4) and centre support (11) using hardware part L and a screwdriver (not provided).

**DO NOT use any power tools as this may damage the frame and will invalidate any claim.**

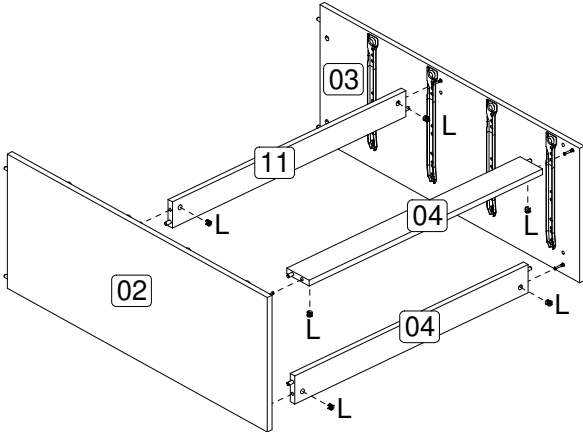
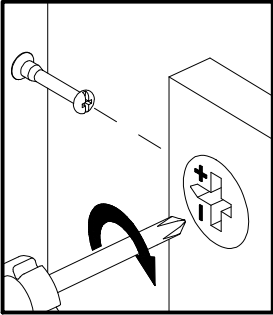

**Step 5:** Attach the top panel (1) using hardware parts L then attach hardware parts E7 to the base using hardware part N. You will need to use a screwdriver (not provided).

**DO NOT use any power tools as this may damage the frame and will invalidate any claim.**

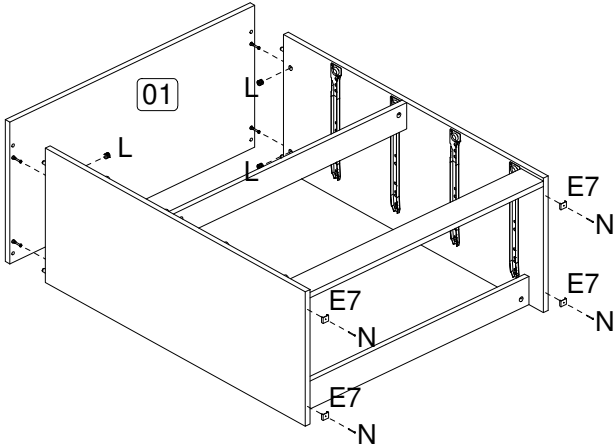

**Step 6:** Connect the back panels (10) using the spine (A6) and secure using hardware part N and a small mallet (not provided).

**DO NOT use any power tools as this may damage the frame and will invalidate any claim.**

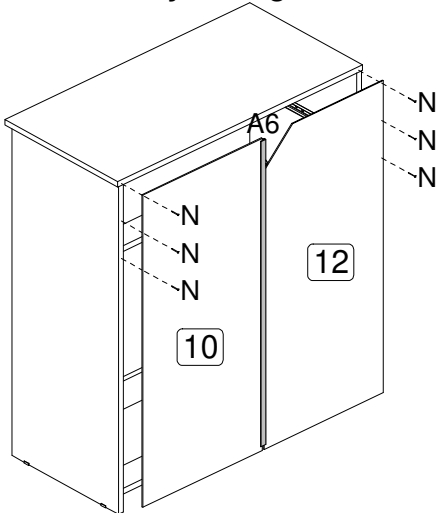

**Step 7:** To secure the item to the wall use hardware parts A, B3 and E9 using a drilling machine (not provided) and a screwdriver (not provided). Then attach hardware part P5 to the item with a screwdriver (not provided).  
**Birlea Furniture advise you use the wall straps provided to further enhance the safety of this product.**

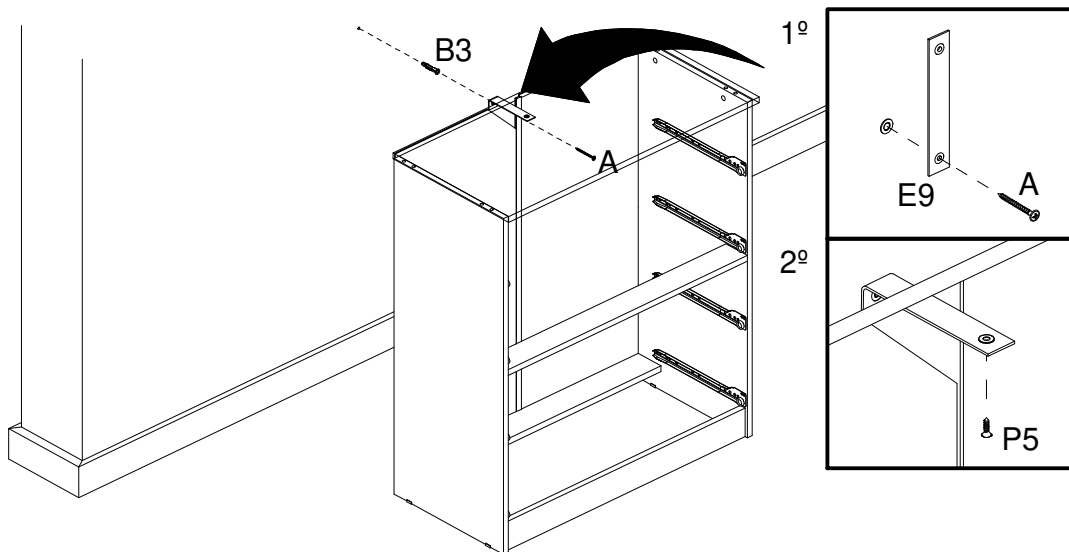

**Step 8:** Attach the left drawer panel (6) and right drawer panel (7) to the drawer back (8) and 9 using hardware part O and a screwdriver (not provided).

**DO NOT use any power tools as this may damage the frame and will invalidate any claim.**

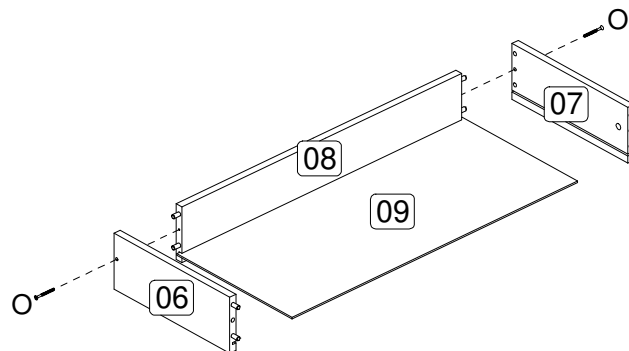

**Step 9:** Attach the drawer front (5) using hardware part A1, L and M with a screwdriver (not provided). Attach the handle W2 using hardware part T with a screwdriver (not provided).

**DO NOT use any power tools as this may damage the frame and will invalidate any claim.**

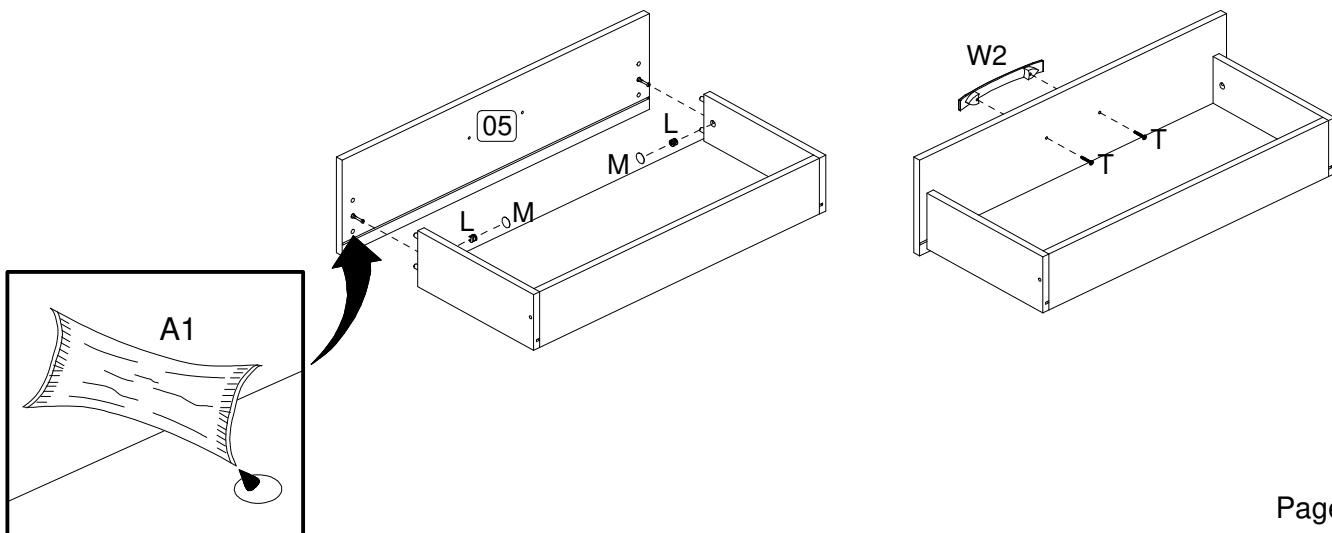

**Step 10:** Attach the drawer slide XC e XD in the underside of the drawer using hardware part P5 with a screwdriver (not provided).

**DO NOT use any power tools as this may damage the frame and will invalidate any claim.**

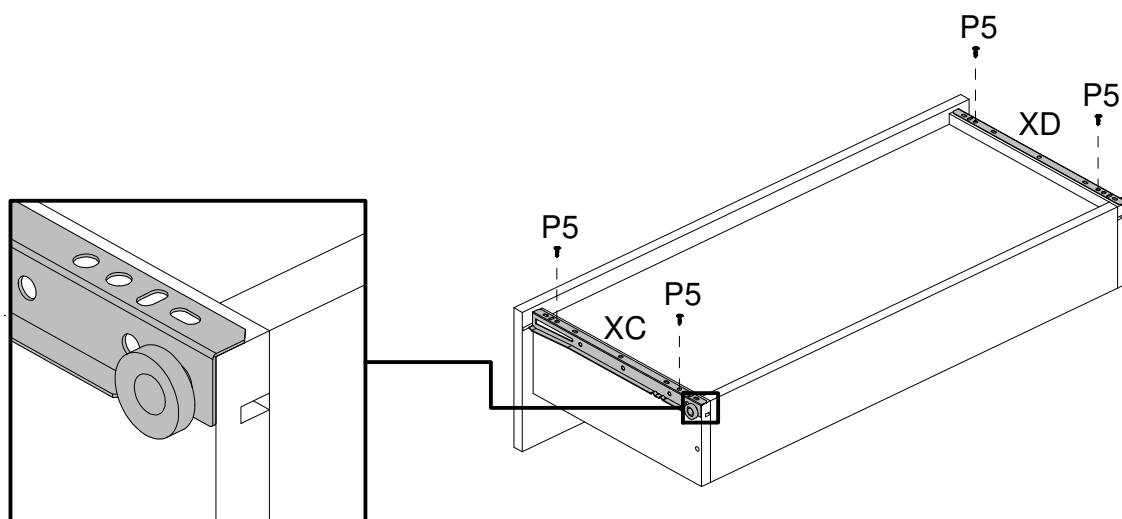

**Step 11:** Insert the drawers on the metallic slide as shown bellow.

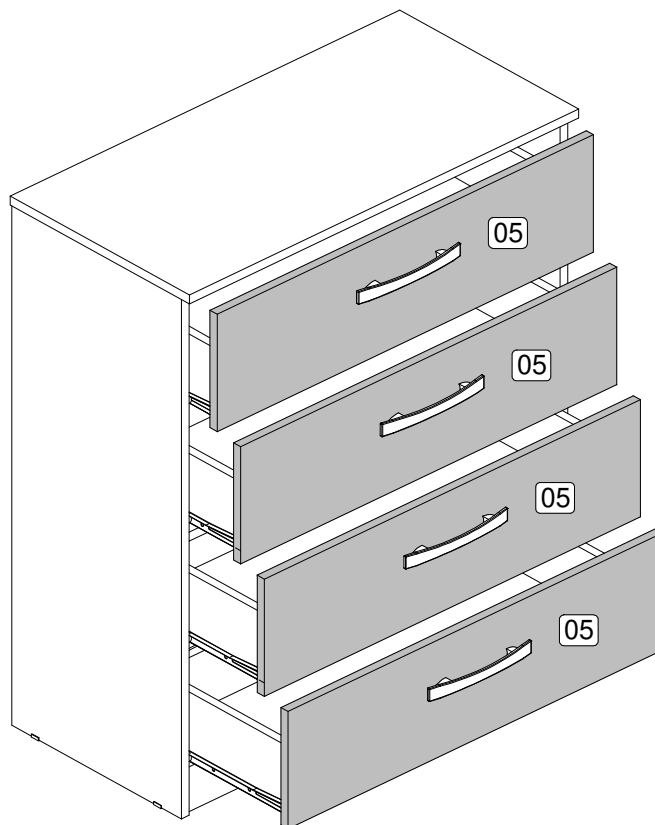
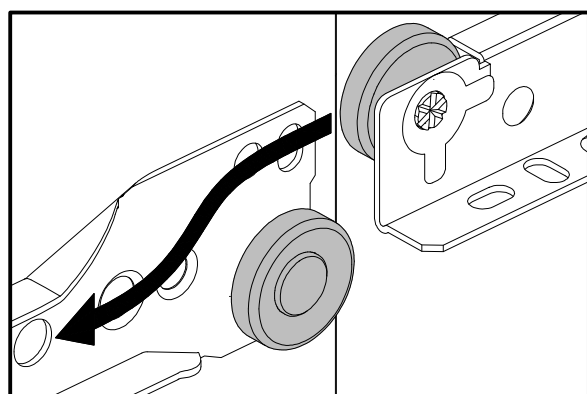

### Additional Information:

- For complete product information, images and dimension diagrams please visit the website [www.birlea.com](http://www.birlea.com)
- If you have any issues with your item please contact the retailer directly you purchased it from who will be able to resolve any issues with Birlea.
- Why don't you send us photos of your assembled furniture to [info@birlea.com](mailto:info@birlea.com) to be shared in our #birleahome feature on Instagram.



# Birlea

Suppliers of inspiration