



# Birlea

Suppliers of inspiration

## Assembly Instructions

---

*Thank you* for  
purchasing a  
Birlea product.

For a chance to win a *Love 2 Shop* voucher simply post a picture of your new product on your preferred social channels tagging Birlea Furniture and using the hashtag **#ShareYourStyle** and **#Birlea**. One winner will be selected at random each month.

To view our full terms and conditions please visit our website. [www.birlea.com](http://www.birlea.com)

---

### Are you happy with your purchase?

**Yes:** That's great, we would love to hear more from you. Please leave us a review on our social media channels or Trustpilot. Your feedback will be greatly appreciated.

**No:** If for any reason there is something missing, indifferent or incorrect with your order, please contact the retailer you purchased the item from. We will work with the retailer to resolve your issue as quickly as possible.



[www.birlea.com](http://www.birlea.com)

The maximum weight allowed on each shelf: 2kg.

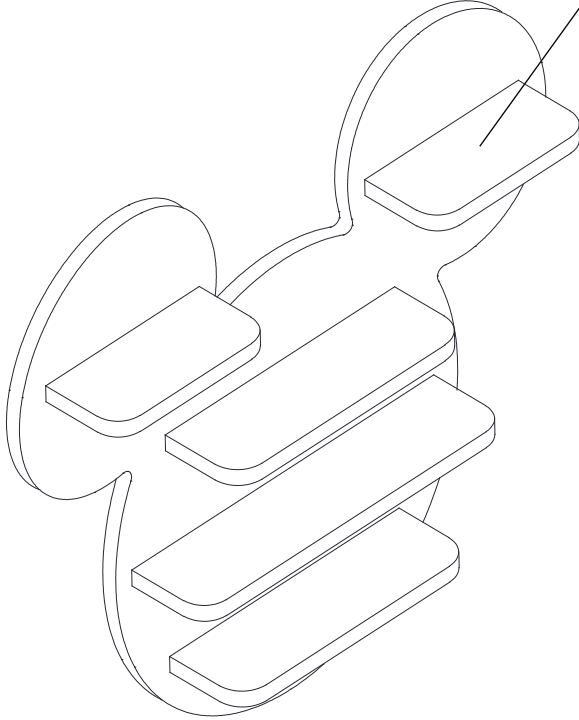

**MICKEY MOUSE SHELF**

Product Code:  
DIS-MICSHU

**BIRLEA FURNITURE LTD**  
**UNIT 6A-1, WEST MEADOW RISE,**  
**CASTLE**  
**DONINGTON, DERBYSHIRE, DE74 2HL**

**CERTIFICATION LABEL**

This storage unit models have been tested by an independent laboratory and is in compliance with FIRA/FRQG C001: 2021- Furniture - Children's Domestic Furniture - General safety requirements; FIRA/FRQG C004: 2016 + A1: 2017- Furniture - Children's Domestic Furniture - Storage Furniture - Requirements for Strength, Stability and Durability.

Factory ID: Manufactured in China  
Date of Manufacture: 1222(MMY)

**WARNING: THIS PRODUCT IS SUITABLE FOR CHILDREN IN THE AGE RANGE 5-12 YEARS.**



**Birlea**

Suppliers of inspiration

# ASSEMBLY INSTRUCTION

## MICKEY MOUSE SHELF

### **IMPORTANT!**

### **READ CAREFULLY AND KEEP FOR FUTURE REFERENCE**

Assembly to be carried out by a competent adult only.

During assembly children should be kept away from the product due to the possible risk of injury.

Do not use the furniture if any part is broken, torn or missing and use only spare parts approved by the manufacturer.

Assemble the furniture on a soft level surface to avoid damaging the product or your floor.

We recommend furniture be assembled near where they will be placed, to avoid moving the product unnecessarily once assembled.

If there is a need to move the furniture, please remove all loose items and have extra hands to help lift the furniture to the desired location. Dragging the furniture will damage both the furniture and the floor.

Ensure that fingers and legs are clear of all adjustments when adjusting this product.

Regularly check and re-tighten (if necessary) all bolts on furniture that you have assembled yourself.

This product is suitable for children in the age range 5-12 years.

### **Care and Maintenance of your Furniture**

Avoid placing hot items directly onto the surface unless using a thick insulation material such as placemats or coasters. Heat may lead to discolouration or other damage to the surface of the product.

Use a soft cloth that has been dampened in water to clean the surface of this product. Do not use abrasive cleaners, furniture wax or polish on the surface of this product, as it may damage the surface.



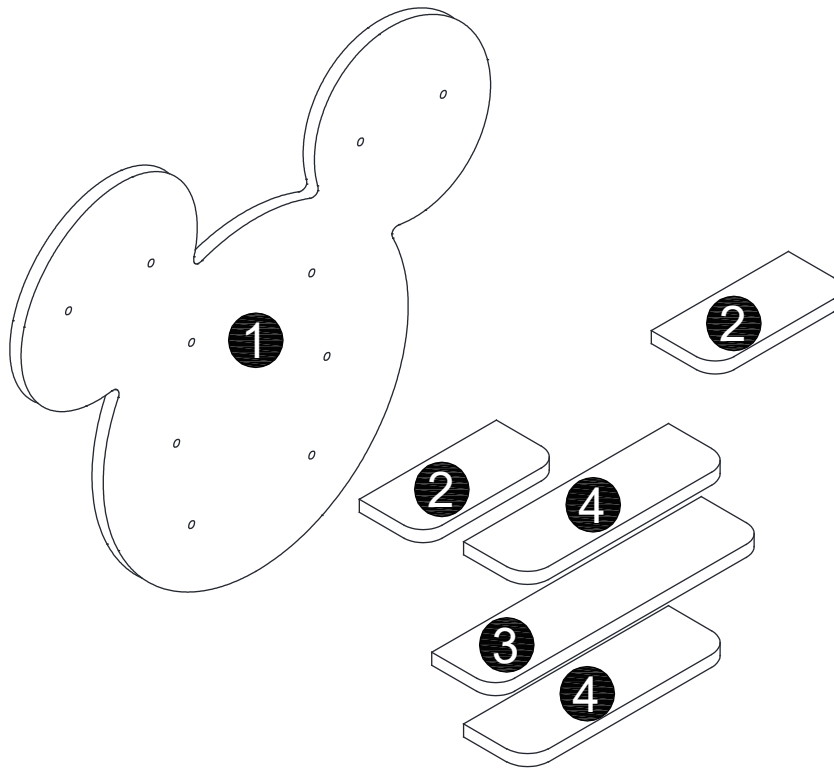

**CAUTION: FREQUENT EXPOSURE TO DIRECT SUNLIGHT OR SIMILAR SOURCES MAY CAUSE THE SURFACE TO DISCOLOUR OR FADE.**





Parts List			
PART	DESCIRPTION	QTY	BOX
1	Back Panel	1	1
2	Shelf	2	1
3	Shelf	1	1
4	Shelf	2	1

## HARDWARE (IN BOX 1)

A		M6x40mm	10	C		Ø25mm	2
B		Ø10x10mm	10	D		M3x10mm	4

\*\*You will need a Phillips head screwdriver and a Flat head screwdriver (not provided).





**Birlea**

Suppliers of inspiration

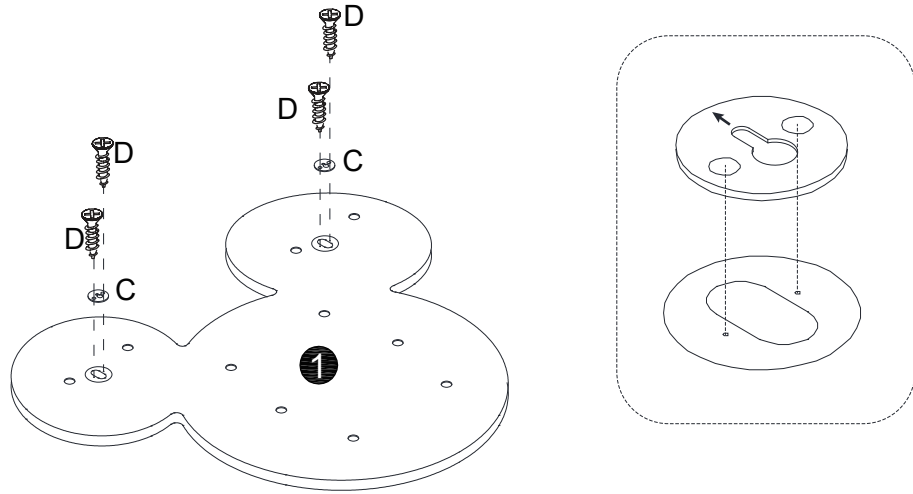

# 01

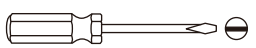
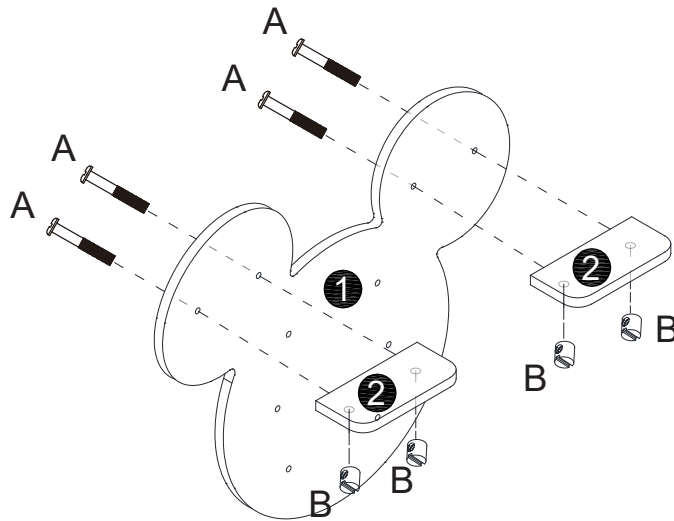

C	 Ø25mm	2
D	 M3x10mm	4

# 02



A	 M6x40mm	4
B	 Ø10x10mm	4





**Birlea**

Suppliers of inspiration

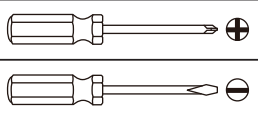
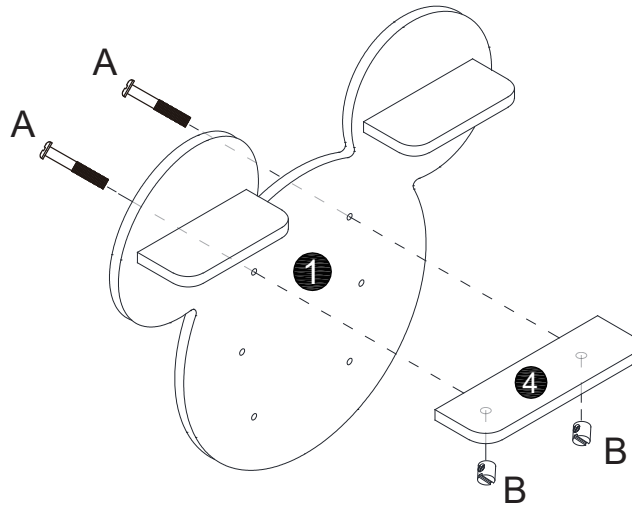

# 03

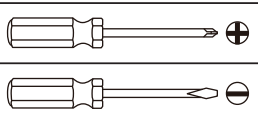
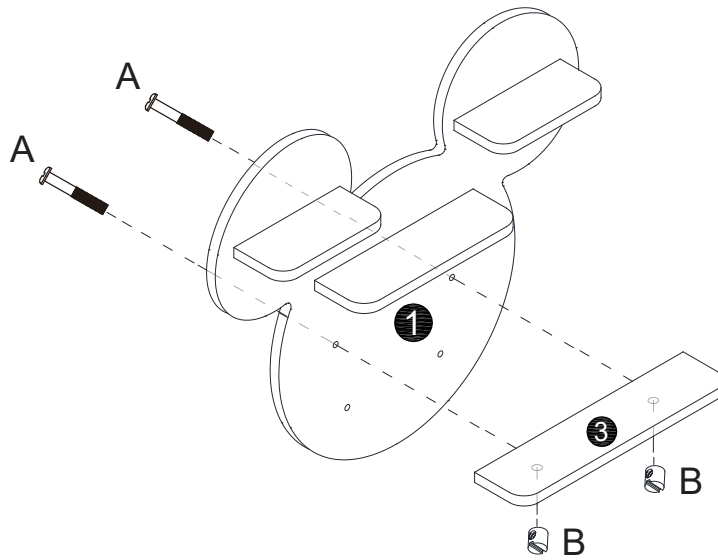

A	 M6x40mm	2
B	 Ø10x10mm	2

# 04



A	 M6x40mm	2
B	 Ø10x10mm	2



**Birlea**

Suppliers of inspiration

# 05

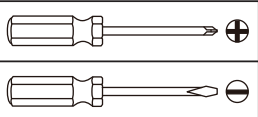
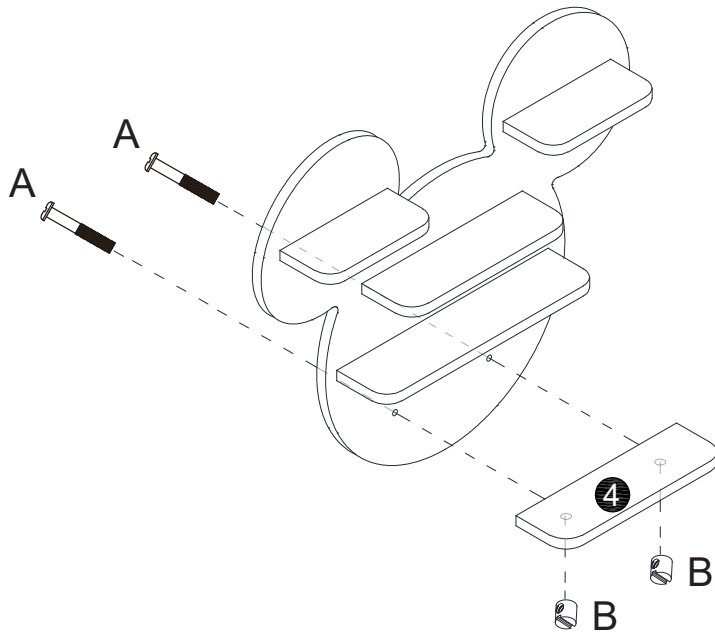

A	 M6x40mm	2
B	 Ø10x10mm	2

# 06

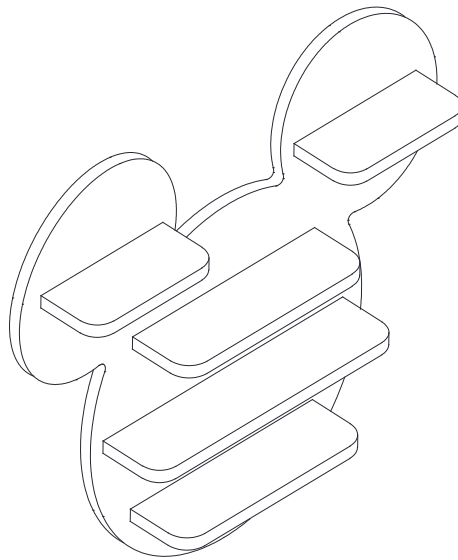

07

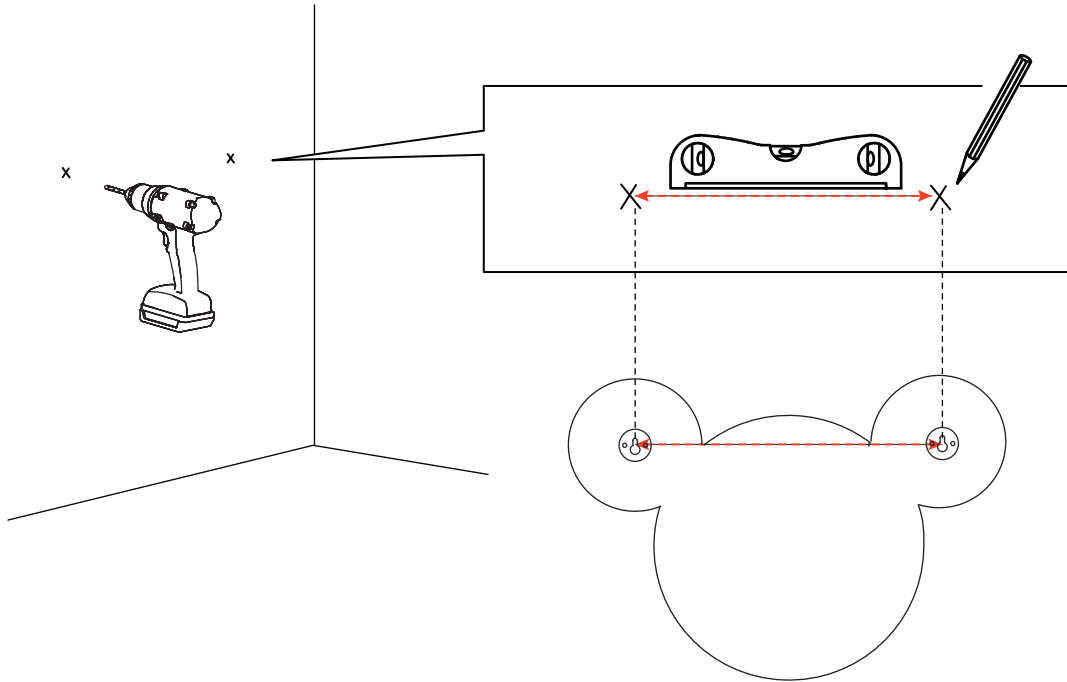

08

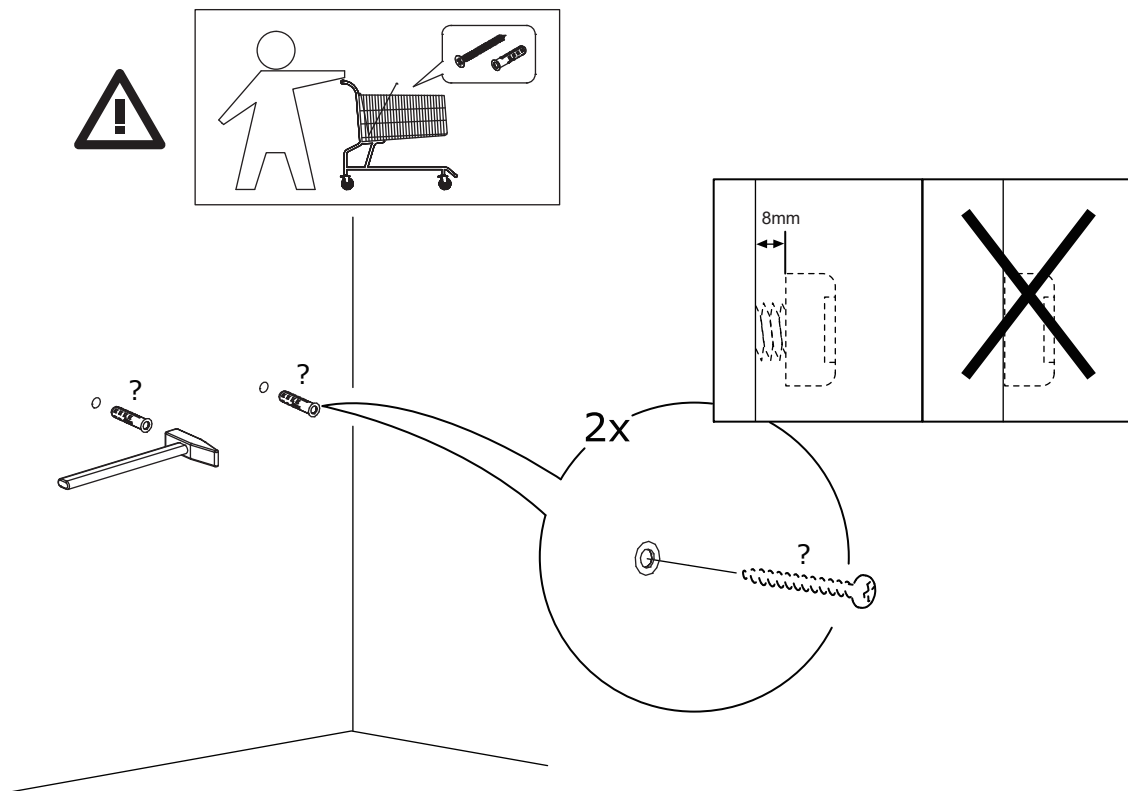

As wall materials vary, screws for fixing to wall are not included. Please contact your DIY or hardware store for advice on the correct type of screws/wall plugs for your type of wall.



**Birlea**

Suppliers of inspiration



09

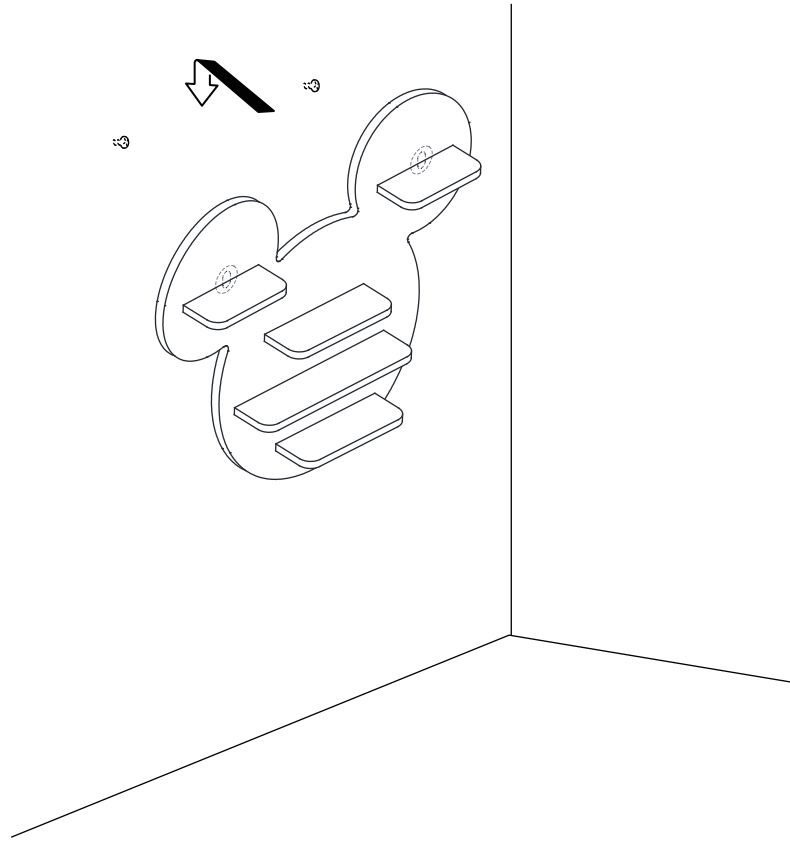

10

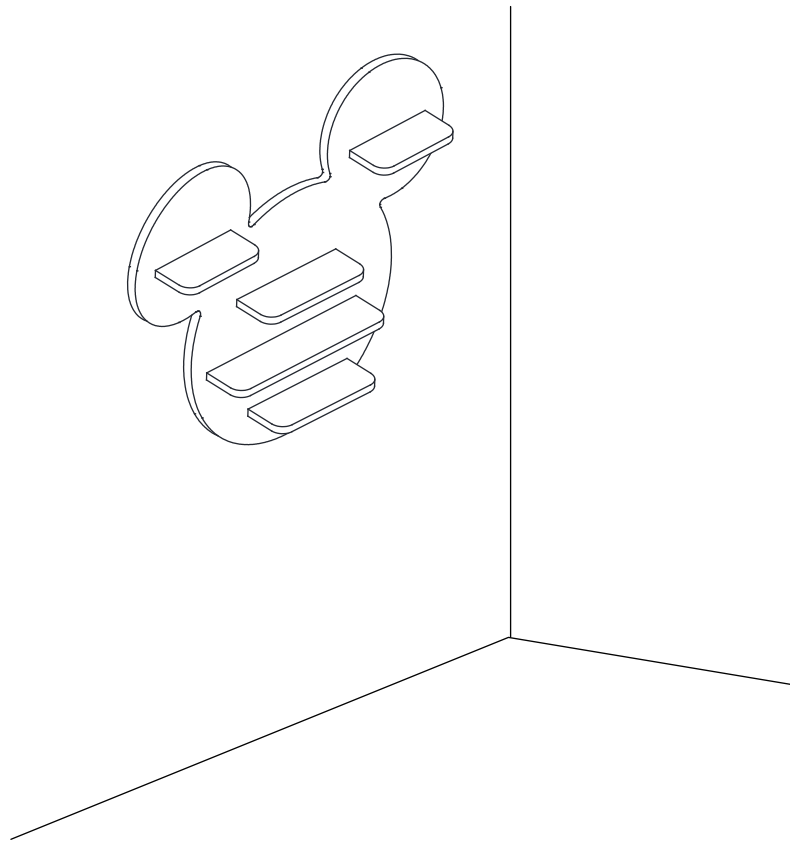

**Birlea**

Suppliers of inspiration

## **Additional Information:**

- For complete product information, images and dimension diagrams please visit the website [www.birlea.com](http://www.birlea.com)
- If you have any issues with your item please contact the retailer directly you purchased it from who will be able to resolve any issues with Birlea.
- Why don't you send us photos of your assembled furniture to [info@birlea.com](mailto:info@birlea.com) to be shared in our [#birleahome](https://www.instagram.com/birleahome) feature on Instagram.



**Birlea**

Suppliers of inspiration